

HELI

S SERIES



4-5 ton
AC ELECTRIC
FORKLIFT

STANDARD EQUIPMENT

- Wide view mast
- Standrad fork
- II(III)fork carriage
- Backrest
- Two-spool control valve
- Battery group
- Standrad seat
- Overhead guard
- Overhead guard raincoat
- LCD combined display
- Solid tyre
- Traction bar
- Attached tools

OPTIONS

- Boom
- Load hawk
- Load bar
- Turning fork
- Back view mirror
- Side shifter
- Paper roll clamp
- Alarm lamp
- Rear work light
- Cab
- Windshield
- Multi function barrel clamp
- Load stabilizer
- Widened fork holder
- Lengthened fork
- Load pusher
- Sleeve on fork
- Rotating flat clamp
- Accessory hydraulic component
- Tilt/Steering cylinder protection sleeve
- Colored tyer
- Wide view triplex mast with full free length
- Customer referred color

HIDRALTUR
CARRETLILLAS ELEVADORAS
AUTHORIZED DEALER

Dirección Comercial: C/Xavier Nogués, 12
Pol. Ind. Can Ribó
08911 Badalona

hidraltura@hidraltura.es www.hidraltura.es



TOP1 FORKLIFT MANUFACTURING AND SALE
IN CHINA CONTINUOUSLY FOR 22 YEARS

© 2013 heli copyright

Catalog No.2013.2 HELI Print

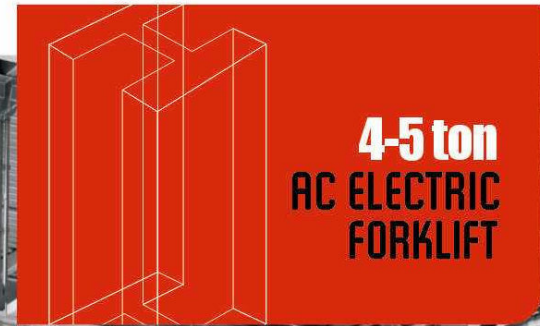

4-5 ton
AC ELECTRIC
FORKLIFT



S SERIES

HELI

CHINESE EXPORT BRAND

Recommended
By China Chamber of Commerce for Import and Export of Machinery
And Electric Products

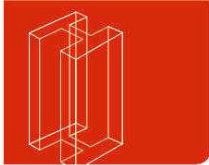

AC ELECTRIC FORKLIFT 4-5 ton

Newly designed wide-view mast



The newly designed wide-view mast enlarges operators' view effectively and lessens the blind area to provide a clearer vision.

Excellent lift control system



Imported Rexroth multi-way valve, reliable quality, energy-saving and efficient.

High efficiency loading/unloading performance

The confluence of double pump, load sensing hydraulic technology, efficient handling efficiency.



- ✓ New low-speed & high-torque lifting motor.
- ✓ MOSFET lifting controller.
- ✓ Low-noise gear pump.
- ✓ The hydraulic dynamic load sensing technology.



Enough operation space

The new optimization layout widens the operator space for ensuring more comfortable and convenient operation.



AC drive motor

Adopt international famous brand integrated drive axle, contains the core components of the AC motor, wet brakes, gearbox.



More intelligent performance

The truck equipped with more intelligence functions not only ensures the safety performance, but also improves the efficiency and reduces energy consumption.

- ✓ AC traction controller.
- ✓ Presence of driver sensing system.
- ✓ Standrad CAN BUS.
- ✓ Emergency power off the main circuit.
- ✓ Self-braking on ramp.
- ✓ Preventing abnormality operating.
- ✓ Electric controller self-protecting.
- ✓ Speed selection function (normal/cutback).



ZAPI CONTROLLER



AC ELECTRIC FORKLIFT 4-5 ton

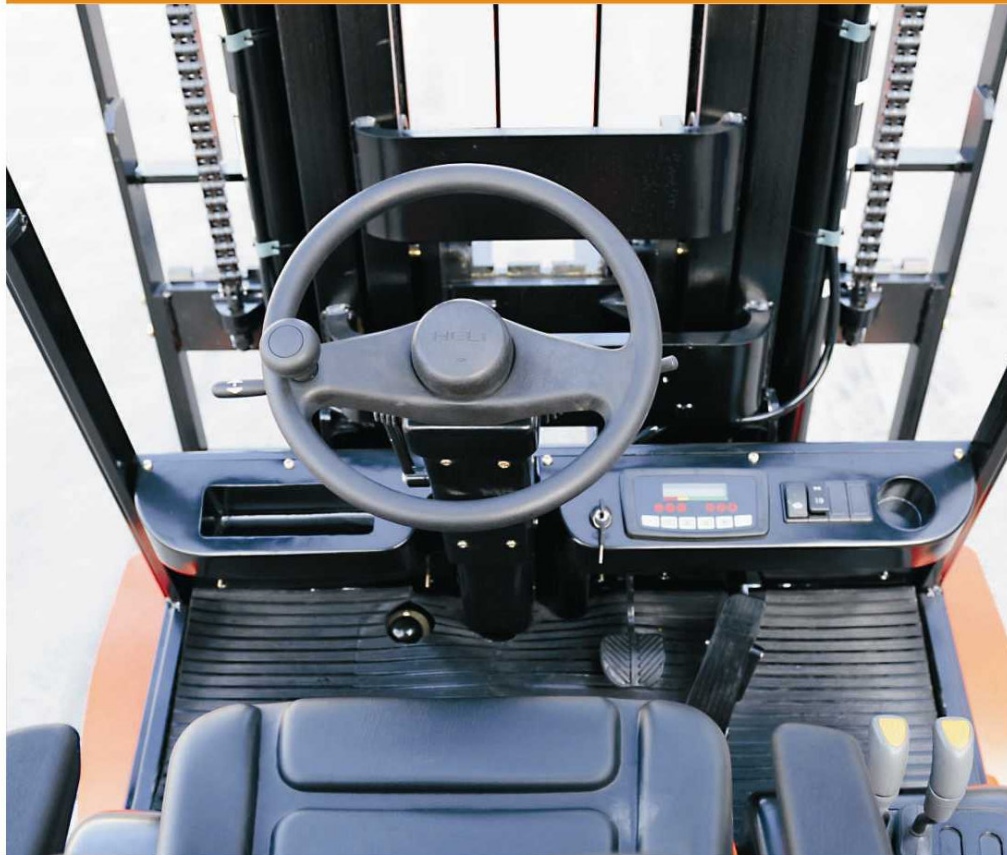

Manufacturers Data and Design Characteristics					
Characteristics					
1.01	Manufacture's Name		HELI		
1.02	Model Designation		CPD40	CPD45	CPD50
1.03	Configuration Number		B2		
1.04	Load Capacity	Q (kg)	4000	4500	5000
1.05	Load Center	c (mm)	500		
1.06	Power Type		Battery		
1.07	Operator Type		Seated		
1.08	Wheelbase	y (mm)	1800		
Wheels & Tyres					
2.01	Tyre Type		Superelastic		
2.02	Tyres Number (Front/Rear)		2/2		
2.03	Tread(centre of tyre),front	b10 (mm)	1120	1120	1158
2.04	Tread(centre of tyre),rear	b11 (mm)	990		
2.05	Tyre Size, Front/Rear		250-15/21x8-9		
Dimensions					
3.01	Load Distance	x (mm)	500		
3.02	Mast Tilt Angle,F/R	a / β (°)	5/10		
3.03	Height with Mast Lowered	h1 (mm)	2382	2375	2374
3.04	Free Lift	h2 (mm)	90		
3.05	Standard Lift Height	h3 (mm)	3000		
3.06	Height with Mast Extended	h4 (mm)	4210	4210	4205
3.07	Overhead Guard Height	h6 (mm)	2290	2290	2285
3.08	Fork Size T × W × L	s/e/L(mm)	55 × 150 × 1070		
3.09	Fork Carriage to DIN 15173 A/B		3A		
3.10	Length to fork face	L2 (mm)	2750		
3.11	Overall Width	L1 (mm)	1350/1250	1350/1250	1394/1320
3.12	Outside Turning Radius	Wa (mm)	2520		
3.13	Ground Clearance at mast ,Loaded	m1 (mm)	140	140	135
3.14	Ground Clearance at centre of wheelbase ,Loaded	m2 (mm)	155	155	150
3.15	Right Stack Aisle width (Pallet size 1000x1000mm, clearance:200mm)	Ast (mm)	4290		
3.16	Right Stack Aisle width (Pallet size 1200x1200mm, clearance:200mm)	Ast (mm)	4420		
Performances					
4.01	Travel Speed,with/without load	km/h	14/15	13.5/14.5	13/14
4.02	Lifting Speed,with/without load	mm/s	300/490	290/490	250/410
4.03	Lowering Speed	mm/s	410		
4.04	Gradient performance with load	%	16	15	13
4.05	Max. draw bar pull with load	N	21000		
4.06	Acceleration time (10 metres) W/O load	s	5.3/5.0	5.5/5.2	5.7/5.4
Weight					
5.01	Total Approximate Weight(W/O battery)	kg	6450 /4750	6850 /4950	7225 /5325
5.02	Axle Loading: Unloaded,Front/Rear	kg	2900/3550	3100/3750	3250/3975
5.03	Axle Loading: Loaded,Front/Rear	kg	9405/1045	10215/1135	11000/1225
Battery					
6.01	Battery Voltage/rated capacity(5h)	V/Ah	80/600	80/650	80/650
6.02	Battery weight	kg	1700	1900	1900
6.03	Battery standard		DIN		
Motor & Controller					
7.01	Drive Motor - 60 Min. Rating	kW	18		
7.02	Pump Motor - 15 Min. Rating	kW	8.6+13		
7.03	Drive Motor Control Method		MOSFET/AC		
7.04	Pump Motor Control Method		MOSFET/DC		
7.05	Service Brake/Parking Brake		Hydraulic/Mechanical		
7.06	Relief Pressure	Mpa	16	18	16

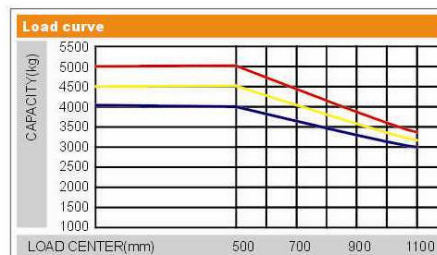
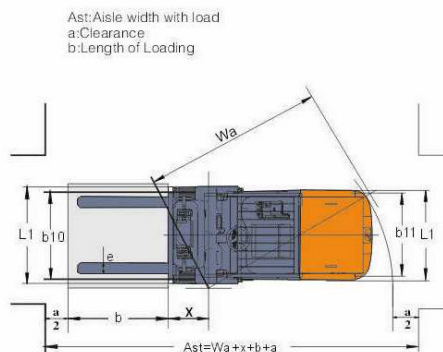
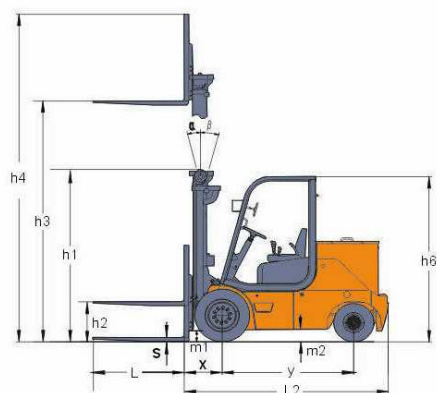

CPD40

CPD45

CPD50

Note:

Vertical axle stands for load capacity while horizontal axle stands for load center. Load center is the distance counted from the front of the fork. The base point of the standard load is the center point of the cubic with the same 1000mm dimension in length, width and height. The load capacity should be down, if mask tilts forward, using non-standard forks or loading goods with extra width. Please notice the different load capacity between different load centers according to load chart.

ZAPI SMART interactive multi-function LCD instrument

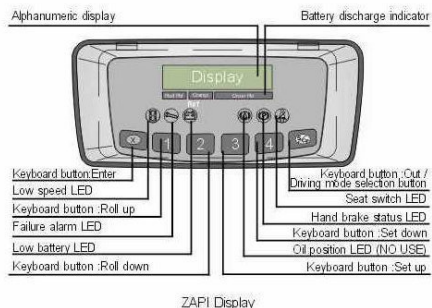

Battery with automatic water inlet device



Battery

Renewable energy technologies

With the use of the excellent load-sensing steering system and AC controlling renewable energy technologies, the forklift is more energy-saving and the working hour of the battery is extended by 15%.

↑ 15%
THE PERFORMANCE OF BATTERY INCREASES

The reliable special instrument gives a complete display of the vital information, like operation status, fault detection, etc. It ensures the operator predominate the vehicle status more intuitive and convenient.

4-5t WIDE VIEW MAST

Mast model	Max. Fork height (mm)	Load Capacity (Load centre 500mm) (kg)			Overall Height (mm)		Tilt Angle (α/β)
		CPD40	CPD45	CPD50	CPD40~45	CPD50	
M300	3000	4000	4500	5000	2382	2374	5/10
M330	3300	4000	4500	5000	2532	2524	5/10
M350	3500	4000	4500	4800	2632	2624	5/10
M370	3700	4000	4375	4625	2732	2724	5/10
M375	3750	4000	4360	4610	2757	2749	5/10
M400	4000	4000	4300	4550	2932	2924	5/10
M425	4250	3900	4200	4450	3057	3049	5/10
M450	4500	3800	4100	4300	3182	3174	5/10
M475	4750	3750	4000	4200	3307	3299	5/10
M500	5000	3650	3900	4100	3432	3424	5/10
M550	5500	3500	3750	3950	3732	3724	5/7
M600	6000	3200	3350	3800	3982	3874	3/5

4-5t WIDE VIEW FULL FREE 3-STAGE MAST

Mast model	Max. Fork height (mm)	Load Capacity (Load centre 500mm) (kg)			Overall Height (mm)		Free lift (With STD backrest) (mm) CPD40~45	Tilt Angle (α/β)
		CPD45	CPD40	CPD50	CPD40~45	CPD50		
ZSM360	3600	3850	4150	4500	2120	2112	900	5/7
ZSM400	4000	3750	4050	4400	2255	2247	1035	5/7
ZSM435	4350	3610	3910	4310	2370	2362	1050	5/7
ZSM450	4500	3550	3850	4250	2420	2412	1200	5/7
ZSM470	4700	3490	3790	4170	2485	2477	1265	5/7
ZSM480	4800	3460	3760	4130	2520	2512	1300	5/7
ZSM500	5000	3400	3700	4050	2635	2627	1415	5/7
ZSM550	5500	3250	3550	3900	2855	2847	1635	3/5
ZSM600	6000	2900	3100	3500	3020	3012	1802	3/5

NOTE: Free lifting height without backrest; +360mm.